

**Condensing with
the Power to Fit**



97%
EFFICIENT

46%
SMALLER

THE ERA OF BIG BOILERS IS OVER

Why do so many condensing boilers look the same and why are they so BIG? Tall welded boxes, virtual copies of each other, mimicking designs decades old. And BIG...is being kind. Most point to lackluster transfer properties of stainless steel. Maybe... we think the industry got lazy. Technology improves overtime and condensing is not immune. The era of BIG, welded, copy cat boxes is over!

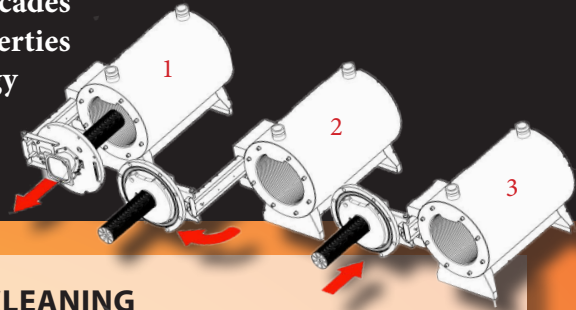

GAME CHANGING ADVANCEMENT

The AMP Series from Thermal Solutions will redefine how you look at condensing boilers and boiler room layouts. AHRI certified at 97%, the AMP is highly efficient and remarkably compact, requiring only half the square footage of everyone else...no one comes close to this package. Large diameter tubes deliver desired waterside characteristics for variable and full flow designs. It is also uniquely serviceable, providing complete access to the burner and combustion chamber. Available in 1000, 1250, 1500, and 2000 mbh inputs. The AMP has the *POWER to FIT*.

SPACE SAVING INNOVATION

Averaging 46% less required space than everyone else, AMP is the perfect solution for tight and shrinking boiler rooms. All models fit through standard doorways and are compact for easy maneuvering. Top water connections further reduce requirements commonly added to rear dimensions. Talk about the *Power to Fit!* An optional racking system doubles the btu's vs. competitive install limitations.

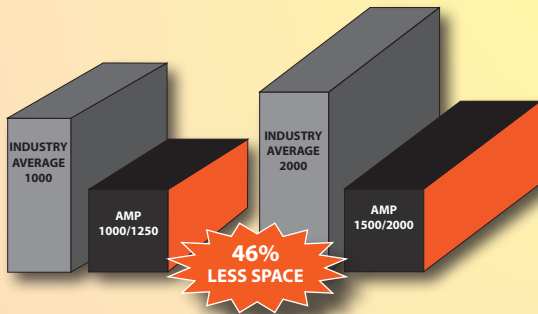

5:1 TURNDOWN

Why 5:1 turndown? Because it works and is proven time after time. No need for multiple set-ups in summer and winter or excess amounts of air, diluting your condensing efficiency at low fire. Reliability is our cornerstone and answering each and every call for heat is paramount.

SERVICE & CLEANING

Can it get any easier? The burner is mounted and fully supported on a swing-out door providing unique and complete access to the burner and combustion chamber. Service, inspections, and cleanings can be completed effortlessly, ensuring long-lasting efficiency year after year.

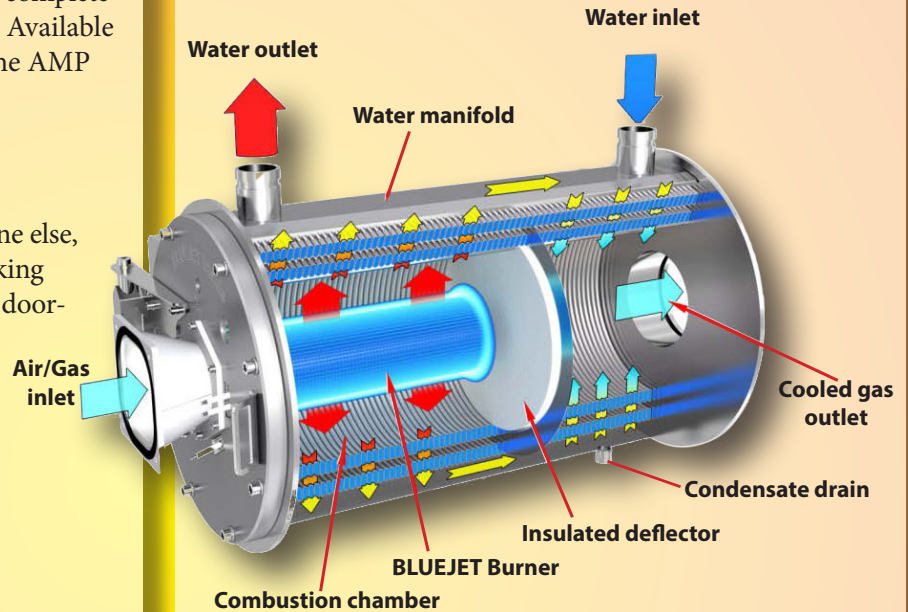

VARIABLE & FULL FLOW PIPING

Optimized for smaller pump selections and electrical conservation, advanced fluidics allow for single pump variable flow systems or primary/secondary layouts. Large diameter, double row tube design delivers desired traits reducing pump sizing vs. competition.

VENTING

Cat IV out of the box or Cat II common venting with an engineered venting system. Capable of up to 200 equivalent feet of vent in AL29-4C, polypropylene or CPVC.

ADVANCED CONTROL PLATFORM – CONCERT™ BOILER CONTROL



Intuitive Icon Navigation

“Touch” and move through our control menus effortlessly. Whether it be commissioning the boiler with the “Quick Setup” menu, pinpointing fault codes with corrective actions in seconds or seamlessly connecting to an EMS. Extensive data archives with graphical displays are available to evaluate boiler performance and make value-added adjustments to maximize boiler & system efficiency.

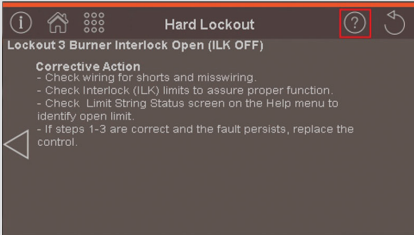

Self-Guiding Diagnostics

Troubleshooting boiler issues has never been this easy! The industry-leading fault identification and correction feature allows the service technician to quickly drill down on the issue, with cause and corrective measures.



Unmatched Archives

With the largest collection of stored operational data (4 months), no stone is left unturned when it comes to evaluating a boiler’s performance and pinpointing adjustment for improvement. The boiler’s onboard energy management system is a true step above all others!

Peer-To-Peer Boiler Sequencing

Unique control logic uses both temperature and firing rate of the connected boilers to sequence up to eight units in unison to optimize system efficiency. Included dual RJ45 connections make peer-to-peer and/or simultaneous EMS communications (ModBus Standard / Other Protocols Optional) a snap without the need of a separate splitter.



USB Data Sharing

Make room on the tool belt for a flash drive as the USB data sharing port has become another important device to have in commissioning (upload/download settings from one boiler to the next), servicing (download data and email file to factory for assistance) and analyzing boiler operation (historical info can be downloaded & saved in .CRV formatted files).

SIMPLIFIED WIRING AND SERVICEABILITY

Low and high voltage fused printed circuit boards (PCB) simplifies wiring, enhances serviceability & troubleshooting with easy to read labeling, and provides electrical protection (spare fuses located on PCB for quick replacement). Other connections include: 120/1/60 voltage and pumps (boiler, system & domestic hot water); alarm; auto & manual reset external limits; enable/disable; DHW demand; 4-20mA remote; sensors (outdoor, remote and DHW); EnviraCOM thermostat; low water cutoff; and flow switch.

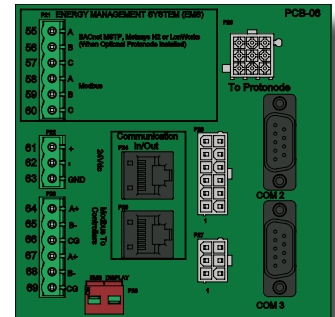

HARMONIZING BOILERS WITH SYSTEMS

Optional control panel integrates all makes of boilers (water or steam) for seamless, single-point connection with EMS. Improves efficiency and operation of condensing, non-condensing, hybrid or steam systems up to 8 units. “Smart Ops” select boiler type (condensing or non-condensing) based on load requirements and inputs of boilers of any size. Selectable Unison and/or Sequential modulation with base load ensures peak efficiency and maximum run time for all types of boiler technologies.

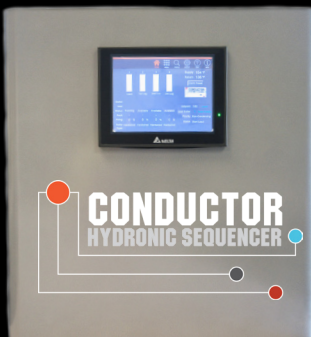

Visit www.ThermalSolutions.com to find out more!



AMP STANDARD EQUIPMENT

PRESSURE VESSEL DESIGN

Watertube stainless steel heat exchanger
ASME Section IV-certified, "H" Stamp
MAWP 160 PSIG & design temp 210°F
Ten Year limited heat exchanger warranty
One year parts and burner warranty

COMBUSTION DESIGN

Stainless steel pre-mix burner
Low NOx emissions (<10 ppm);
Full modulation, 5:1 turndown
Natural gas
4" wc to 14" wc inlet gas pressure
Direct spark ignition system
High & low gas pressure switches w/ manual reset
Zero governor gas valve
Variable speed combustion blower
Air proving switch
Blocked vent switch

VENTING

CPVC, polypropylene or stainless steel materials acceptable
Air intake - sealed combustion or room air
Category IV individual venting
Category II common venting with engineered vent system

BOILER EQUIPMENT

Concert Boiler Control™
High limit w/auto reset temperature control
High limit w/ manual reset safety temperature control

Low water cutoff w/ manual reset
Water flow switch
Supply & return water temperature sensors
Flue gas temperature sensor
Air vent valve
Condensate trap
Blocked condensate switch
Pressure & temperature gauge
ASME safety relief valve

ELECTRICAL DESIGN

High voltage printed circuit board (PCB)
120 VAC / 60 Hertz / 1-phase power supply
Optional 208-230 VAC / 60 Hertz / 1-phase power supply
120 VAC manual reset external limit contacts
Three sets of pump contacts
PCB fused connections

Printed Circuit Board (PCB)

24 VAC enable/disable sensor contacts
24 to 120 VAC proving switch or auto reset external limit contacts
24 to 120 VAC lockout alarm contacts
24 VAC EnviraCom thermostat contacts
DHW demand contacts
Remote header sensor contacts
DHW tank sensor contacts
Outdoor air sensor contacts
Peer-to-peer communication contacts
EMS interface contacts
Remote 4-20mA contacts

AMP OPTIONAL EQUIPMENT

- Hydronic kit (boiler pump & condensate neutralizer)
- Condensate neutralizer
- 30, 50, 60, 75, 100 & 125 psi ASME safety relief valve
- External high limit w/ manual reset safety switch
- Alarm buzzer w/ silencing switch
- Extended Warranty

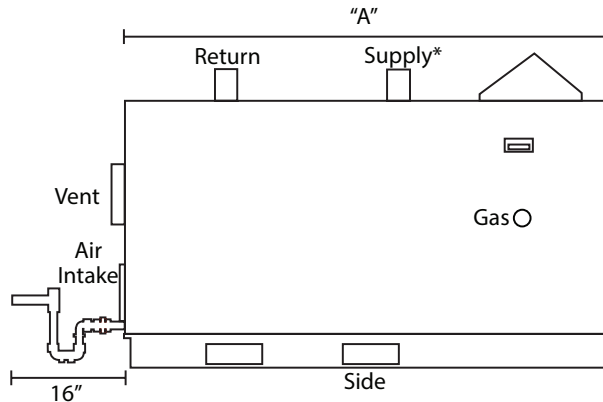

CONCERT BOILER CONTROL

Dashboard - color touch screen display, 4.3"

- Intuitive icon navigation
- "Quick" setup menus
- "Real time" BTU/H display*

Two (2) temperature demand inputs

- Outdoor air reset curve for each input
- Time of day setback capability (EnviraCom thermostat must be installed)

Three (3) pump control

- Boiler pump
- Domestic hot water (DHW) pump
- System pump
- Alternative control to isolation valve, combustion air damper, or standby loss damper
- Pump overrun for heat dissipation
- Pump exercise
- Pump rotor seizing protection

Peer-to-peer boiler communications

- Multiple size boiler sequencing up to 8 units
- Two (2) boiler start/stop trigger*
- Lead boiler automatic rotation

Energy management system (EMS) interface

- Firing rate and water temperature based algorithms for multiple boilers; loss of EMS signal defaults to local boiler settings*
- 4-20mA dc input/output
- ModBus Input/Output
- Simultaneous interface with peer-to-peer

USB data port transfer*

- Upload settings between boilers
- Download parameters for troubleshooting
- Import data into .CRV formatted files for performance analysis

Energy efficiency enhancer

- Anti-cycling technology
- Multiple boiler base load common rate
- Outdoor air temperature reset curve
- Warm weather shutdown
- Boost temperature & time
- Ramp delay
- Over-temperature safeguarding

Self-guiding diagnostics

- Identifies fault
- Describes possible problems
- Provides corrective actions

Time/Date stamp on alarms and lockouts*

Unmatched archives

- Historical trends - collects up to 4 months of data
- Event History - up to 3,000 alarms, lockouts, and cycle & run times
- Cycle & run time - boilers & pumps
- Resettable

Domestic hot water priority

- DHW tank piped with priority in the boiler loop
- DHW tank piped as a zone in the system with the pumps controlled by the Concert control

Other features

- Factory default settings*
- Three level password security
- Frost protection
- Sensor monitoring and control
- Low water flow safety control & indication
- Proportion integral derivative (PID) parameters for central heat, DWH, sequencer and fan
- Built-in brown-out protection

* Unique to Thermal Solutions

CONCERT BOILER CONTROL OPTIONS

- Communications gateway - BACnet, LonWorks, Metasys N2 or ModBus TCP/IP compatible
- 0-10v signal converter
- Header sensor, direct immersion
- Header sensor, well mounted (with well)
- Outdoor air reset sensor (wired or wireless)
- Conductor Hydronic Sequencer

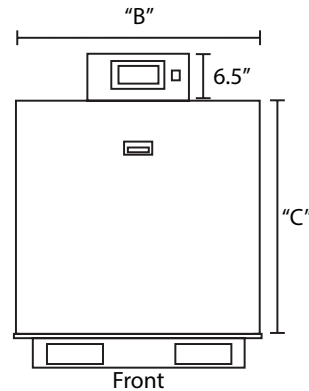

*Supply manifold not pictured, but includes:

- Pressure/temperature gauge
- ASME relief valve
- Water flow switch and
- Low water cut off

SPECIFICATIONS, DIMENSIONS, & RATINGS

Models	Input		Gross Output (MBH)	"A" Length (In)	"B" Width (In)	"C" Height (In)	Gas Conn. (In)	Supply Grooved Conn (In)	Return Grooved Conn (In)	Vent Size (In)	Air Intake Size (In)	Approx Shipping Weight (Lbs)
	Min (MBH)	Max (MBH)										
AMP-1000	200	1000	970	45	35	36.5	1 NPT	3	2.5	8	8	780
AMP-1250	250	1250	1213	45	35	36.5	1 NPT	3	2.5	8	8	780
AMP-1500	300	1500	1455	65	35	36.5	1.25 NPT	3	2.5	8	8	1050
AMP-2000	400	2000	1940	65	35	36.5	1.25 NPT	3	2.5	8	8	1150

©2018 Thermal Solutions Products, LLC P.O. Box 3244, Lancaster, PA 17604-3244
PH: 717-239-7642, F: 877-501-5212 www.thermalsolutions.com

108599-01 R1

